

# TOSHIBA

Toshiba Barcode Printer

## B-EX4T3 SERIES

Owner's Manual



<Regulation>

**EAC**

## TABLE OF CONTENTS

1.	PRODUCT OVERVIEW.....	2
1.1.	Introduction.....	2
1.2	Features.....	2
1.3	Unpacking.....	2
1.4	Appearance.....	3
1.4.1	Dimensions.....	3
1.4.2	Front View.....	3
1.4.3	Rear View.....	3
1.4.4	Operation Panel.....	4
1.4.5	Interior.....	4
1.5	Options.....	5
2.	PRINTER SETUP.....	6
2.1	Installation.....	7
2.2	Connecting the Power Cord.....	8
2.3	Loading Supplies.....	9
2.3.1	Loading the Media.....	10
2.3.2	Loading the Ribbon.....	11
2.4	Connecting the Cables to Your Printer.....	12
2.5	Turning the Printer ON/OFF.....	13
2.5.1	Turning ON the Printer.....	13
2.5.2	Turning OFF the Printer.....	13
3.	MAINTENANCE.....	14
3.1	Cleaning.....	14
3.1.1	Print Head/Platen/Sensors.....	14
3.1.2	Covers and Panels.....	15
3.1.3	Optional Cutter Module.....	16
4.	PRINTER SPECIFICATIONS.....	17
5.	SUPPLY SPECIFICATIONS.....	27
5.1	Media.....	27
5.1.1	Media Type.....	27
5.1.2	Detection Area of the Transmissive Sensor.....	29
5.1.3	Detection Area of the Reflective Sensor.....	30
5.1.4	EFFECTIVE PRINT AREA OF PAPER.....	31
5.2	Ribbon.....	32
5.3	Recommended Media and Ribbon Types.....	32
5.4	Care/Handling of Media and Ribbon.....	33

# 1. PRODUCT OVERVIEW

## 1.1. Introduction

Thank you for choosing the TEC B-EX4T3 series barcode printer. This Owner's Manual contains from general set-up through to how to confirm the printer operation using a test print, and should be read carefully to help gain maximum performance and life from your printer. For most queries please refer to this manual and keep it safe for future reference. Please contact your Toshiba Tec representative for further information concerning this manual.

## 1.2 Features

This printer has the following features:

- The print head block can be opened providing smooth loading of media and ribbon.
- Various types of media can be used as the media sensors can be moved from the center to the left edge of the media.
- Web based functions such as remote maintenance and other advanced network features are available.
- Superior hardware, including the specially developed 23.6 dots/mm (600 dots/inch) thermal print head which will allow very clear print at a printing speed of 2, 3, 4, 5 or 6 inches/sec.
- Besides the optional Cutter Module, there is also an optional Peel off Module, Centronics I/F card, Expansion I/O Card, Narrow width platen kit.

## 1.3 Unpacking

Unpack the printer as per the Unpacking Instructions supplied with the printer.

### **NOTES:**

1. *Check for damage or scratches on the printer. However, please note that Toshiba Tec shall have no liability for any damage of any kind sustained during transportation of the product.*
2. *Keep the cartons and internal packing for future transportation of the printer.*

## 1.4 Appearance

The names of the parts or units introduced in this section are used in the following chapters.

### 1.4.1 Dimensions

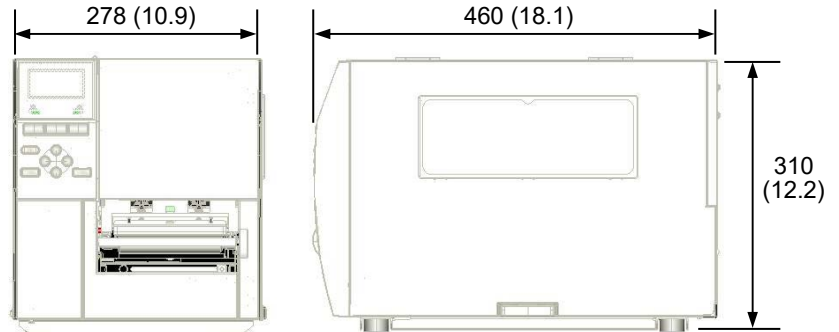

Dimensions in mm (inches)

### 1.4.2 Front View



### 1.4.3 Rear View

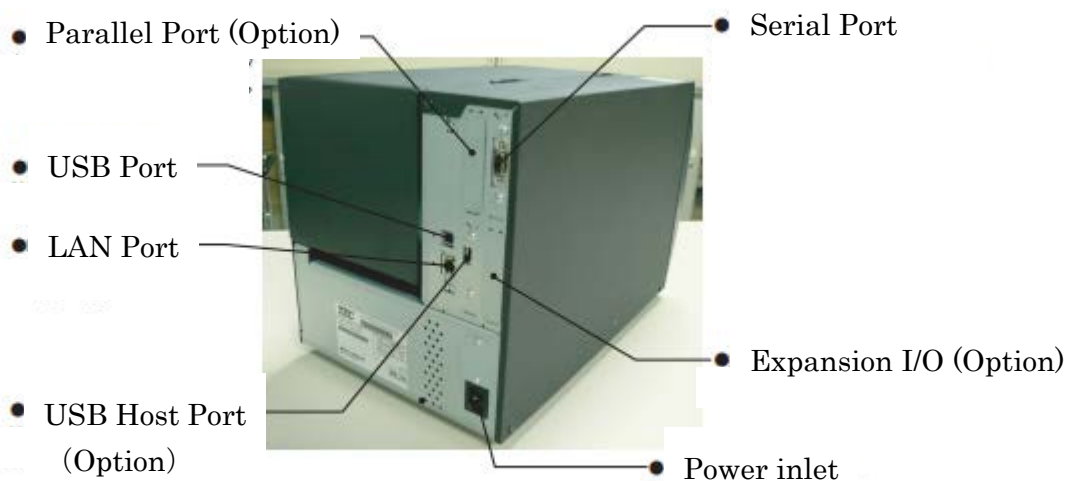

1.4.4 Operation Panel

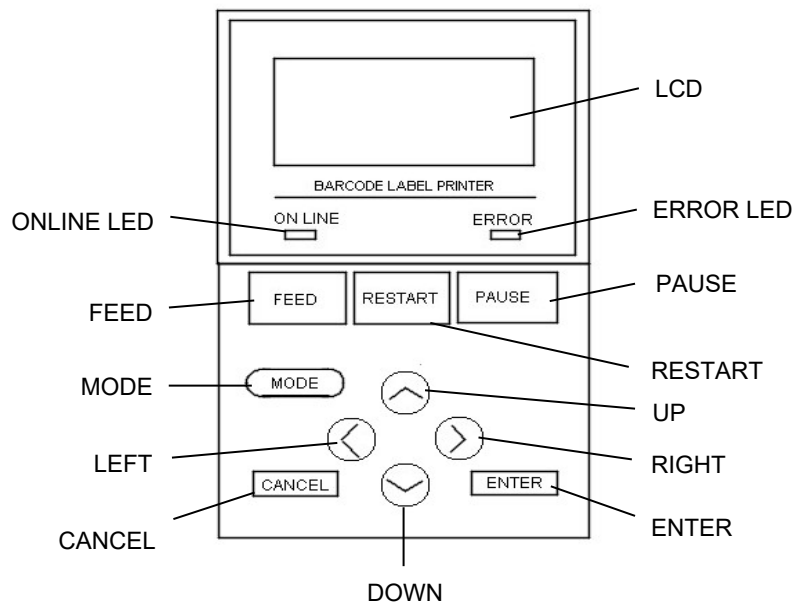

Please see **Section 3** for further information about the Operation Panel.

1.4.5 Interior

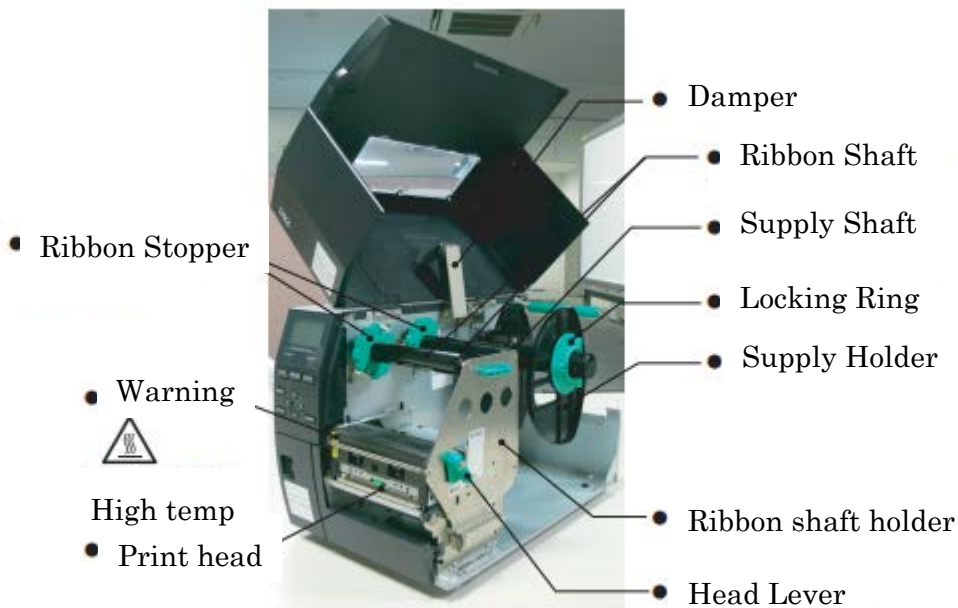

## 1.5 Options

Option Name	Type	Description
Disc cutter module	B-EX204-QM-R	Disc cutter Each time media is cut, the media feed is stopped.
Peel off module	B-EX904-H-QM-R	This allows use of on-demand (peel-off) operation or to take-up labels and backing paper together when using the rewind guide plate.
High precision peel off module	B-EX904-HH-QM-R	This allows use of on-demand (peel-off) operation or to take-up labels and backing paper together when using the rewind guide plate. To support peel off minimum 3mm length label.
Expansion I/O interface card	B-EX700-IO-QM-R	Installing this card in the printer allows connection to an external device with the exclusive interface.
Parallel interface card	B-EX700-CEN-QM-R	Installing this card provides a Centronics interface port.
RTC & USB host interface card	B-EX700-RTC-QM-R	This card holds the current time: year, month, day, hour, minute, second and provides a USB host interface.

**NOTE:**

*To purchase the optional kits, please contact the nearest authorized Toshiba Tec representative or Toshiba Tec Head Quarters.*

## 2. PRINTER SETUP

This section outlines the procedures to setup your printer prior to its operation. The section includes precautions, loading media and ribbon, connecting cables, setting the operating environment of the printer and performing an online print test.

Setup Flow	Procedure	Reference
Installation	After referring to the Safety Precautions in this manual, install the printer in a safe and stable location.	2.1 Installation
Connecting the power cord	Connect a power cord to the power inlet of the printer, then to an AC outlet.	2.2 Connecting the Power Cord
Loading the media	Load a label stock or tag stock.	2.3.1 Loading the Media
Media sensor position alignment	Adjust the position of feed gap sensor or black mark sensor according to the media being used.	2.3.1 Loading the Media
Loading the ribbon	Load the ribbon.	2.3.2 Loading the Ribbon
Connecting to a host computer	Connect the printer to a host computer or network.	2.4 Connecting the Cables to Your Printer
Turning the power ON	Turn on the printer power.	2.5 Turning the Printer ON/OFF
Printer setting	Set the printer parameters in the system mode.	2.6 Printer Setting
Installing the printer driver	If necessary, install the printer driver on your host computer.	2.7 Installing the Printer Drivers
Print test	Make a print test from your operating environment and check the print result.	2.8 Print Test
Position and Print Tone Fine adjustment	If necessary, fine adjust the print start position, cut/strip position, print tone, etc.	2.9 Position and Print Tone Fine Adjustment
Automatic threshold setting	If the print start position cannot be detected properly when pre-printed label are used, set the threshold automatically.	2.10 Threshold Setting
Manual threshold setting	If the print start position cannot be detected properly even after automatic threshold setting is performed manually set the threshold.	2.10 Threshold Setting



## 2.1 Installation

To insure the best operating environment and to assure the safety of the operator and equipment, please observe the following precautions.

- Operate the printer on a stable, level surface in a location free from excessive humidity, high temperature, dust, vibration and direct sunlight.
- Keep your work environment static free. Static discharge can cause damage to delicate internal components.
- Make sure the printer is connected to a clean source of AC power and no other high-voltage devices, that may cause line noise interference, are connected to the same mains.
- Assure that the printer is connected to the AC mains with a three-prong power cable that has the proper ground (earth) connection.
- Do not operate the printer with the cover open. Be careful not to allow fingers or articles of clothing to get caught in any of the moving parts, especially the optional cutter mechanism.
- Make sure to turn off the power and remove the power cord whenever working inside the printer. For example when changing the ribbon, loading the media, or cleaning the printer.
- For best results, and longer printer life, use only Toshiba Tec recommended media and ribbons.
- Store the media and ribbons in accordance with their specifications.
- This printer mechanism contains high-voltage components; therefore you should never remove any of the covers of the machine as you may receive an electrical shock. Additionally, the printer contains many delicate components that may be damaged if accessed by unauthorized personnel.
- Clean the outside of the printer with a clean, dry cloth or a clean cloth slightly dampened with a mild detergent solution.
- Use caution when cleaning the thermal print head as it will become very hot while printing. Wait until it has had time to cool before cleaning. Use only the Toshiba Tec recommended print head cleaner to clean the print head.
- Do not turn off the printer power or remove the power plug while the printer is printing or while the ON LINE lamp is flashing.

## 2.2 Connecting the Power Cord

### CAUTION!

1. Make sure that the printer Power Switch is turned to the OFF position (O) before connecting the Power Cord to prevent possible electric shock or damage to the printer.
2. Connect the Power Cord to a supply outlet with a properly grounded (earthed) connection.

1. Make sure that the printer Power Switch is in the OFF (O) position. Connect the Power Cord to the printer as shown in the figure below.

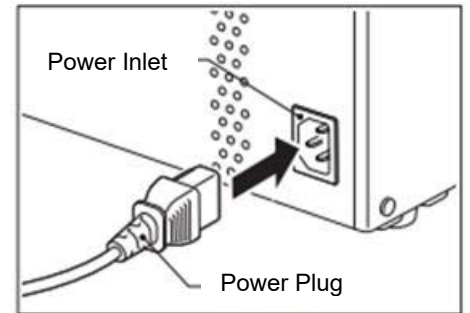
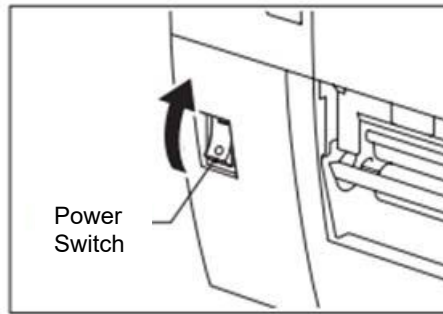

2. Plug the other end of the Power Cord into a grounded outlet as shown in the figure below.

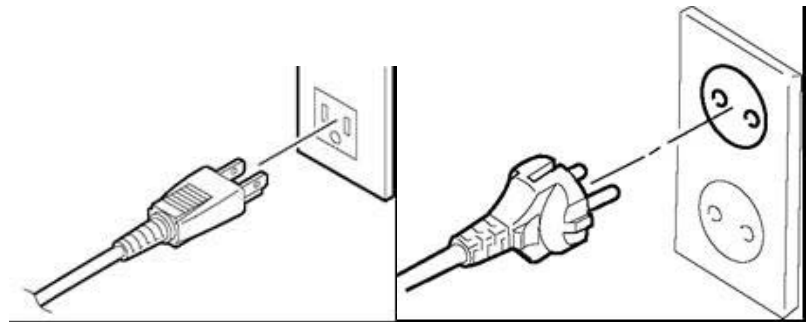

[Example of US Type]

[Example of EU Type]

## 2.3 Loading Supplies

### WARNING!

1. Do not touch any moving parts. To reduce the risk of fingers, jewelry, clothing, etc., being drawn into the moving parts, be sure to load the media once the printer has stopped moving completely.
2. The Print Head becomes hot immediately after printing, allow it to cool before loading the media.
3. To avoid injury, be careful not to trap your fingers while opening or closing the cover.

### CAUTION!

1. Be careful not to touch the Print Head Elements when lifting the Print Head Block. This may cause missing dots due to static electricity or other print quality problems.
2. When loading or replacing the media or ribbon, be careful not to damage the print head with hard objects like watches or rings.



Care must be taken not to allow the metal or glass part of a watch to touch the print head edge.

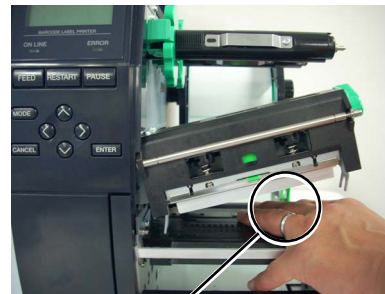

Care must be taken not to allow a metal object like a ring to touch the print head edge.

Since the print head element can be easily damaged by shock, please treat it carefully and do not hit it with hard objects.

### 2.3.1 Loading the Media

The following procedure shows the steps to properly load the media into the printer so that it feeds straight through the printer.

The printer prints both labels and tags.

1. Turn off the power and open the Top Cover.
2. Turn the Head Lever to the **FREE** position and release the Ribbon Shaft Holder Plate.
3. Open the Print Head Block.

**NOTES:**

1. When the Head Lever is turned to **FREE** position, the Print Head can be raised.
2. To enable printing the Head Lever must be set to the **LABEL2** position. (This ensures that the Print Head is closed.)  
However, proper position may differ depending on media. So **LABEL1** position is reserved.
3. Do not turn the Locking Ring counterclockwise too far or it may come off the Supply Holder.

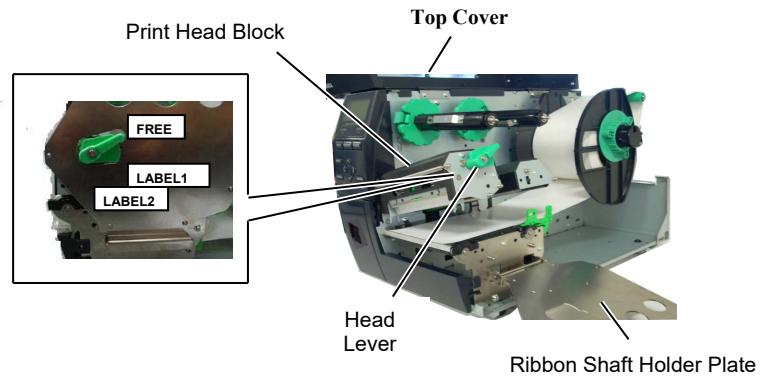

4. Turn the Locking Ring counterclockwise and remove the Supply Holder from the Supply Shaft.

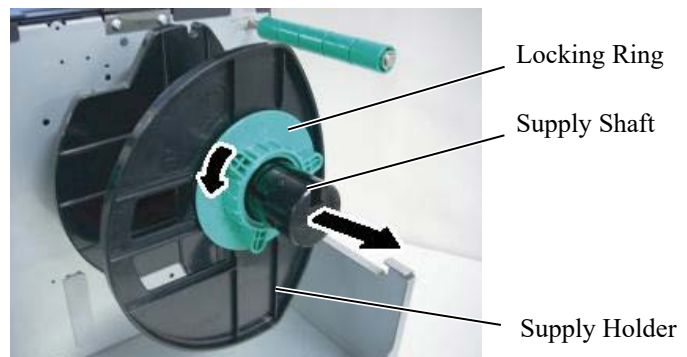

5. Put the media on the Supply Shaft.
6. Pass the media around the Guide Shaft, then pull the media towards the front of the printer.

**2.3.1 Loading the Media (Cont.)**

**NOTE:**  
Do not over-tighten the Locking Ring of the Supply Holder.

7. Align the tab of the Supply Holder with the groove in the Supply Shaft, and push the Supply Holder against the media until the media is held firmly in place. This will center the media automatically. Turn the Locking Ring clockwise to secure the Supply Holder.

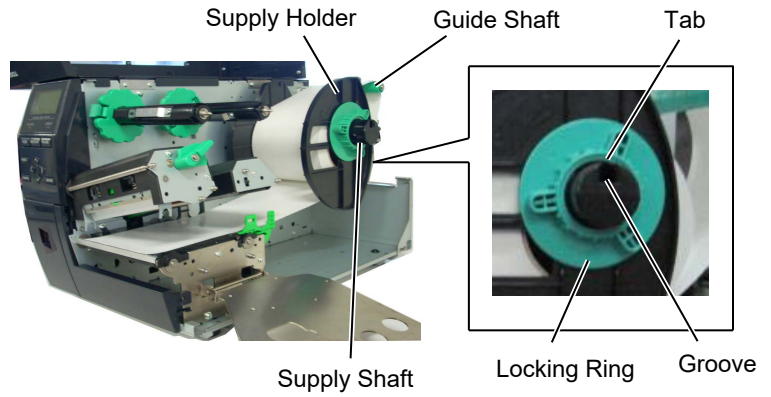

In the case of media which is inside wound.

In the case of media which is outside wound.

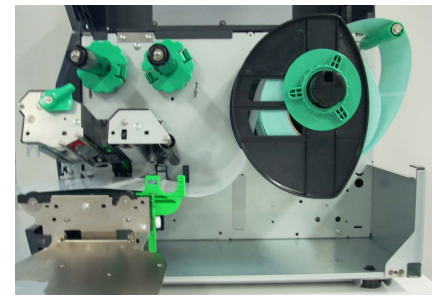
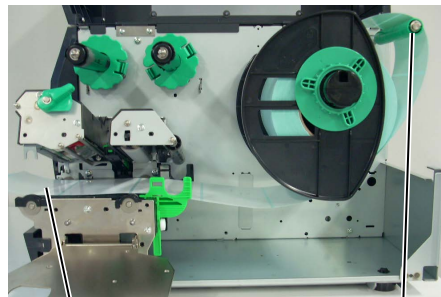

8. Place the media between the Media Guides and adjust them to the media width. Once in the correct position tighten the Locking Screw.
9. Check that the media's path through the printer is straight. The media should be centered under the Print Head.

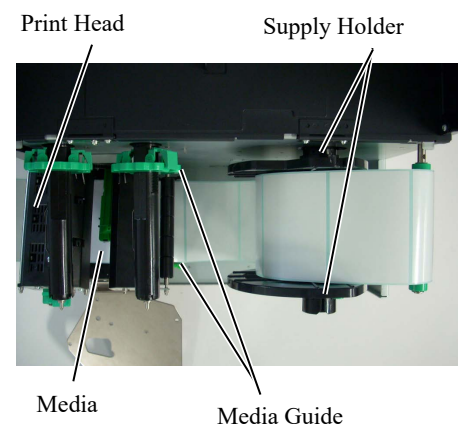
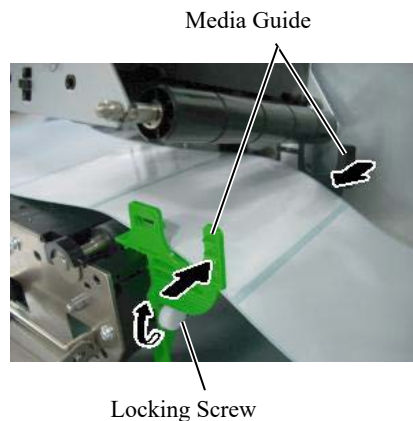

**2.3.1 Loading the Media (Cont.)**

- 10. Lower the Print Head Block.
- 11. Once the media is loaded it may be necessary to set the Media Sensors used to detect the start position for label or tag.

**Setting the Feed Gap Sensor position**

- (1) Manually move the Media Sensor so that the Feed Gap Sensor is positioned at the center of the labels. (● indicates the position of the Feed Gap Sensor).

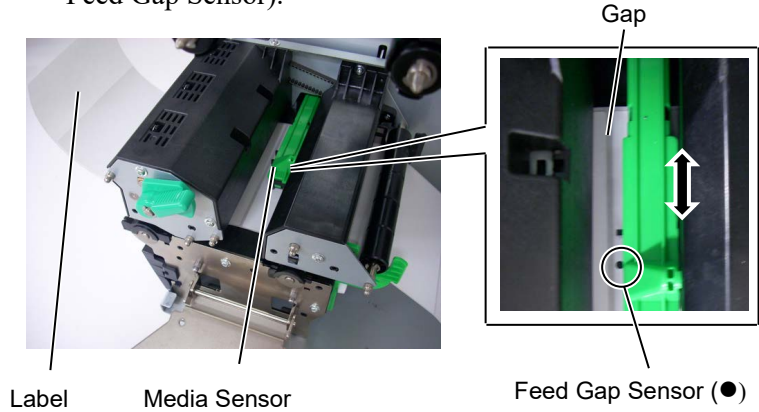

**NOTE:**  
*Be sure to set the black mark sensor to detect the center of the black mark, otherwise a paper jam or no paper error may occur.*

**Setting the Black Mark Sensor position**

- (1) Pull about 500 mm of media out of the front of the printer, turn the media back on itself and feed it under the Print Head past the sensor so that the black mark can be seen from above.
- (2) Manually move the Media Sensor so that the Black Mark Sensor is in line with the center of the black mark on the media. (■ indicates the position of the Black Mark Sensor).

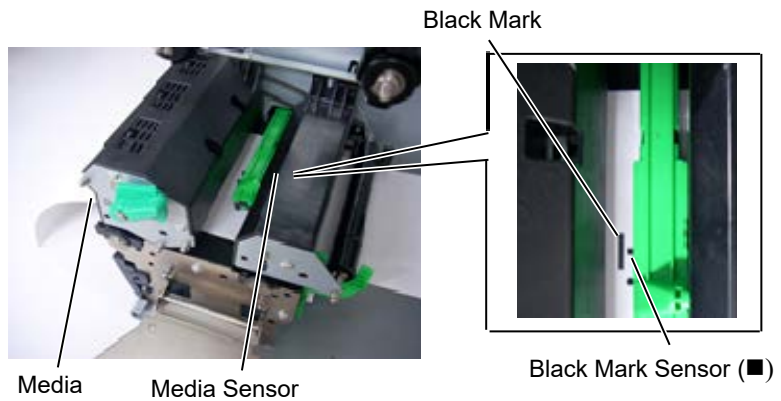

### 2.3.1 Loading the Media (Cont.)

12. Batch mode  
In the batch mode, the media is continuously printed and fed until the number of labels/tags specified in the issue command have been printed.

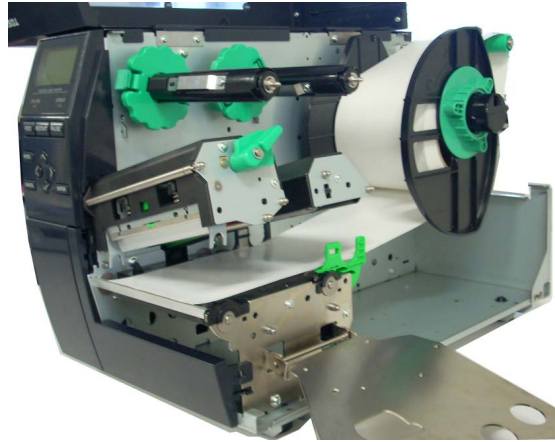



### 2.3.1 Loading the Media (Cont.)

- **When the cutter module is fitted:**

**! WARNING!**

The cutter blade is sharp, so care must be taken not to injure yourself when handling the cutter.

When the optional cutter module is fitted, insert the leading edge of the media into the cutter until it comes out the media outlet of the cutter cover. The media is automatically cut.

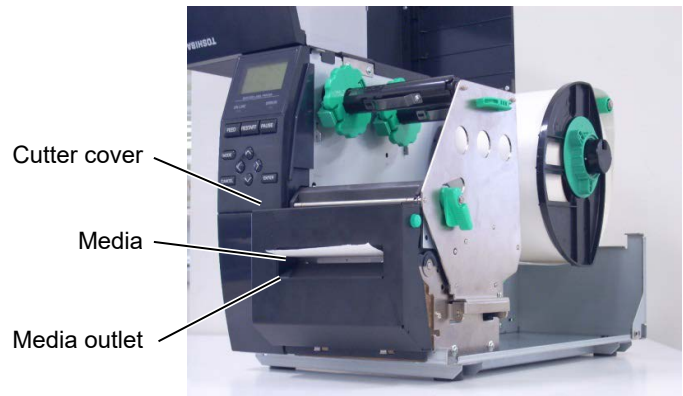

**CAUTION:**

1. Be sure to cut the backing paper of the label. Cutting labels will cause the glue to stick to the cutter, which may affect the cutter quality and shorten the cutter life.
2. Cutting tag paper whose thickness exceeds the specified value may affect the cutter life.



● **When the high-precision peel-off module is fitted:**

When the optional peel-off module is fitted, a label is automatically removed from the backing paper at the strip plate as each label is printed.

1. Press the peel-off unit release button to open the peel-off unit.

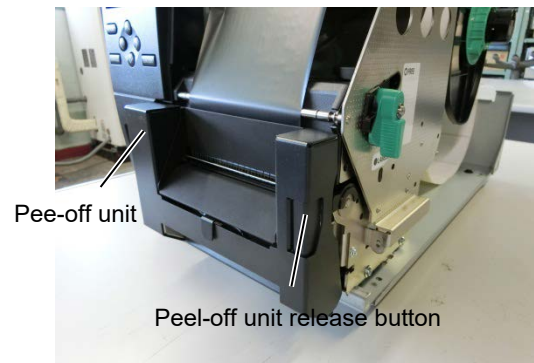

2. Remove enough labels from the leading edge of the media to leave 200mm of backing paper free.

3. Insert the leading edge of the backing paper under the backing paper feed roller.



4. Close the peel-off unit until it clicks.

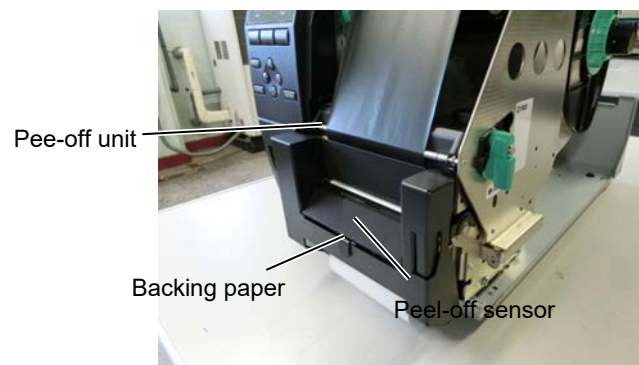

5. Manually move the peel-off sensor so that it is in line with the center of labels coming out of the media outlet. (Basically, align the sensor with the center of the media outlet)

6. Set the ribbon shaft holder plate and turn the head lever to LABEL2 position.

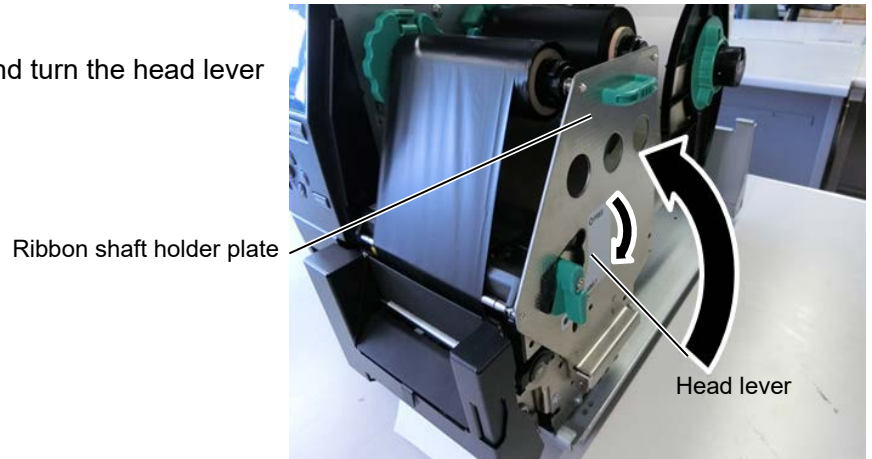

7. Close the top cover.



● **When the peel-off module is fitted:**

1. Remove enough labels from the leading edge of the media to leave 500mm of backing paper free.
2. Pull the backing paper out of the media outlet, then insert the leading edge of the backing paper under the strip plate.
3. Wind the backing paper onto the take-up spool and fix it in position with the take-up clip. (Wind the paper counterclockwise around the spool.)
4. Rotate the take-up spool counterclockwise a few times to remove any slack in the backing paper.
5. Set the selection switch mounted on the rewinder Ass'y to STANDARD PEEL OFF position.

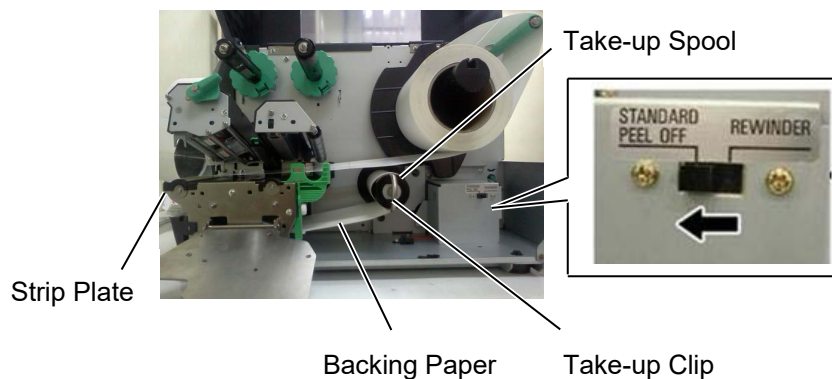

**NOTES:**

1. Be sure to set the selection switch to **STANDARD/PEEL OFF** position.
2. Fit the take-up clip so that the longer side of the clip is fitted into the shallow groove in the take-up spool.
3. Insert the take-up clip fully.
4. Backing paper can be wound directly onto the take-up spool or a paper core fitted on the take-up spool. When winding backing paper directly onto the Take-up spool, detach the spring plate from the take-up spool by removing the screw. Otherwise, it may be difficult to pull out the wound backing paper roll. Wind the backing paper onto the take-up spool two or three times, then fasten the backing paper with the take-up clip. When using a paper core, put a core on the take-up spool without removing the spring plate, and attach the leading edge of the backing paper to the core with adhesive tape. The take-up clip is not necessary.

### 2.3.2 Loading the Ribbon

**NOTES:**

1. *When attaching the ribbon stoppers, make sure that the pinchers face into the printer*
2. *Be sure to remove any slack in the ribbon before printing. Printing with a wrinkled ribbon will reduce the print quality.*
3. *The Ribbon Sensor is mounted on the rear of the Print Head Block to detect a ribbon end. When a ribbon end is detected a "NO RIBBON" message will appear on the display and the ERROR LED will illuminate.*

1. Grasp the tabs on the top and bottom of the Ribbon Stoppers and move them back to the end of the Ribbon Shaft.

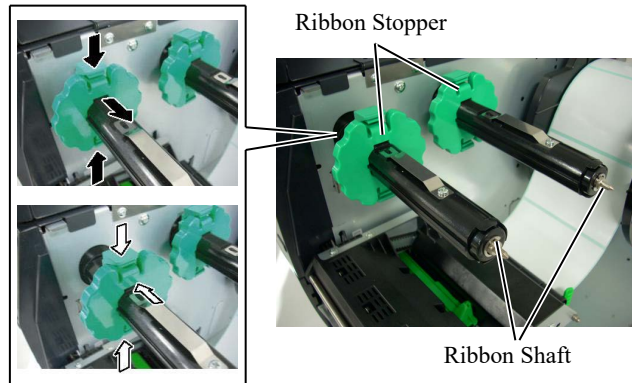

2. Leaving plenty of slack between the ribbon spools, place the ribbon onto the Ribbon Shafts as shown below.

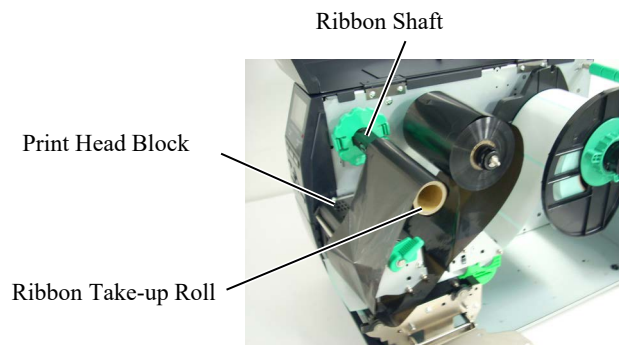

**Ribbon path**

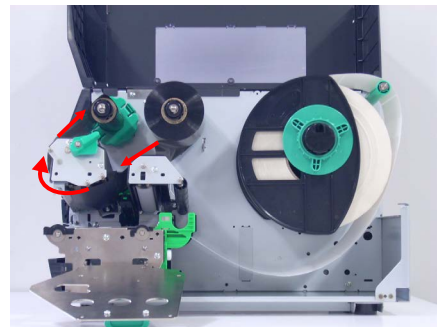

### 2.3.2 Loading the Ribbon (Cont.)

3. Slide the Ribbon Stoppers along the Ribbon Shafts so that the ribbon will be centered when fitted.
4. Lower the Print Head Block and set the Ribbon Shaft Holder Plate aligning its holes with the Ribbon Shafts.
5. Take up any slack in the ribbon. Wind the leading tape onto the ribbon take-up roll until the ink ribbon can be seen from the front of the printer.

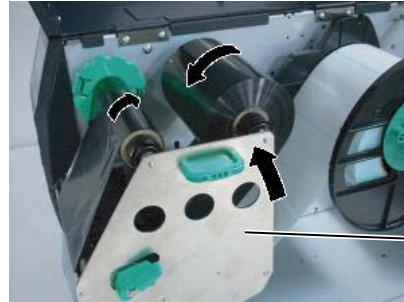

6. Turn the Head Lever to **Label2** position to close the Print Head.
7. Close the Top Cover.

## 2.4 Connecting the Cables to Your Printer

The following paragraphs outline how to connect the cables from the printer to your host computer, and will also show how to make cable connections to other devices. Depending on the application software you use to print labels, there are 4 ways to connect the printer to your host computer. These are:

- An Ethernet connection using the printer's standard LAN connector.
- A USB cable connection between the printer's standard USB connector and your host computer's USB port. (Conforming to USB 2.0)
- A serial cable connection between the printer's RS-232 serial connector and one of your host computer's COM ports.
- A parallel cable connection between the printer's optional parallel connector and your host computer's parallel port (LPT).

For details, refer to **APPENDIX 2**.

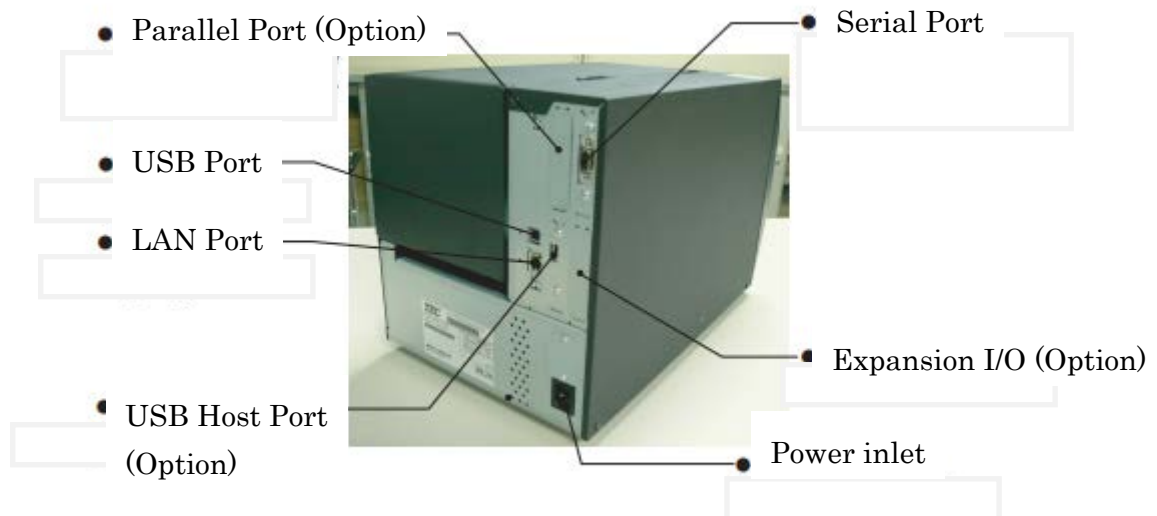

## 2.5 Turning the Printer ON/OFF

When the printer is connected to your host computer it is good practice to turn the printer ON before turning on your host computer and turn OFF your host computer before turning off the printer.

### 2.5.1 Turning ON the Printer

#### **CAUTION!**

Use the power switch to turn the printer On/Off. Plugging or unplugging the Power Cord to turn the printer On/Off may cause fire, an electric shock, or damage to the printer.

#### **NOTE:**

If a message other than ON LINE appears on the display or the ERROR LED lamp is illuminated.

1. To turn ON the printer power, press the Power Switch as shown in the diagram below. Note that (|) is the power ON side of the switch.

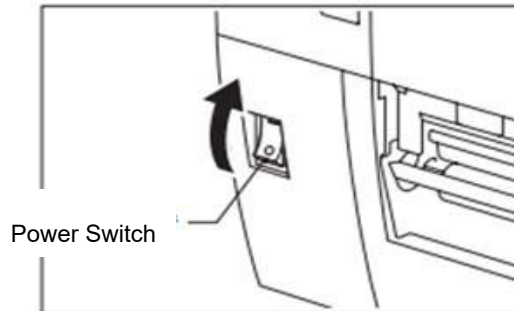

2. Check that the ON LINE message appears in the LCD Message Display and that the ON LINE and POWER LED lights are illuminated.

### 2.5.2 Turning OFF the Printer

#### **CAUTION!**

1. Do not turn off the printer power while the media is being printed, as this may cause a paper jam or damage to the printer.
2. Do not turn off the printer power while the ON LINE lamp is blinking as this may cause damage to your computer.

1. Before turning off the printer Power Switch verify that the ON LINE message appears in the LCD Message Display and that the ON LINE LED light is on and is not flashing.
2. To turn OFF the printer power press the Power Switch as shown in the diagram below. Note that (O) is the power OFF side of the switch.

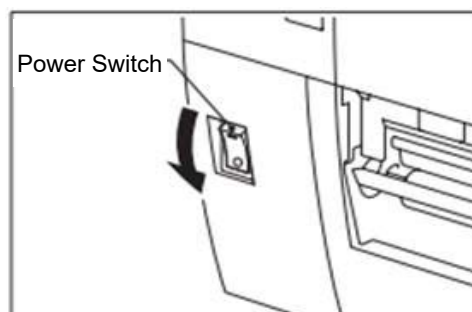



## 3. MAINTENANCE

### WARNING!

1. Be sure to disconnect the power cord before performing maintenance. Failure to do this may cause an electric shock.
2. To avoid injury, be careful not to pinch your fingers while opening or closing the cover and print head block.
3. The print head becomes hot immediately after printing. Allow it to cool before performing any maintenance.
4. Do not pour water directly onto the printer.

### CAUTION!

1. Do not use any volatile solvent including thinner and benzene, as this may cause discoloration to the cover, print failure, or breakdown of the printer.
2. Do not touch the Print Head Element with bare hands, as static may damage the Print Head.

## 3.1 Cleaning

This chapter describes how to perform routine maintenance.

To ensure the continuous high quality operation of the printer, you should perform a regular maintenance routine. For high usage it should be done on a daily basis. For low usage it should be done on a weekly basis.

### 3.1.1 Print Head/Platen/Sensors

To maintain the printer performance and print quality, please clean the printer regularly, or whenever the media or ribbon is replaced.

1. Turn off the power and unplug the printer.
2. Open the Top Cover.
3. Turn the Head Lever to the “FREE” position, and then release the Ribbon Shaft Holder Plate.
4. Open the Print Head Block.
5. Remove the ribbon and media.

### CAUTION!

When cleaning the print head, be careful not to damage the print head with hard objects like watches or rings.



Care must be taken not to allow the metal or glass part of a watch to touch the print head edge.



Care must be taken not to allow a metal object like a ring to touch the print head edge.



### 3.1.1 Print Head/Platen/Sensors (Cont.)

**NOTE:**

Please purchase the Print Head Cleaner from your authorized Toshiba Tec service representative.

6. Clean the Print Head Element with a Print Head Cleaner or a cotton swab or soft cloth slightly moistened with alcohol.

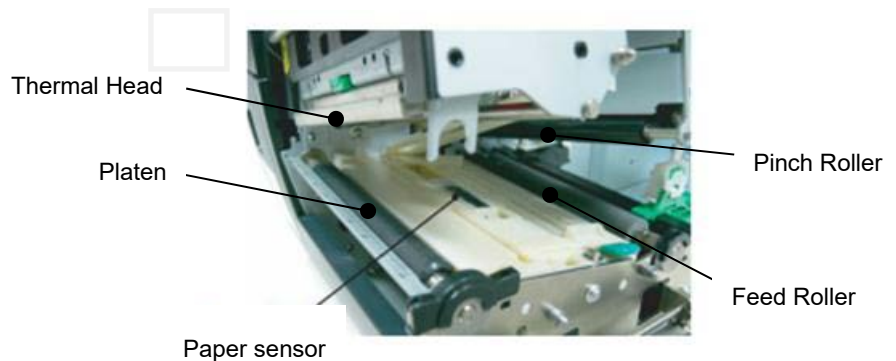

7. Wipe the Platen, Feed Roller, and Pinch Roller with a soft cloth slightly moistened with alcohol. Remove dust or foreign substances from the internal parts of the printer.
8. Wipe the Feed Gap Sensor and Black Mark Sensor with a dry soft cloth.

### 3.1.2 Covers and Panels

**CAUTION!**

1. **DO NOT POUR WATER** directly onto the printer.
2. **DO NOT APPLY cleaner or detergent** directly onto any cover or panel.
3. **NEVER USE THINNER OR OTHER VOLATILE SOLVENT** on the plastic covers.
4. **DO NOT clean the panel, covers, or the supply window with alcohol** as it may cause them to discolor, lose their shape or develop structural weakness.

Wipe the covers and panels with a dry soft cloth or a cloth slightly moistened with a mild detergent solution.

### 3.1.3 Optional Cutter Module

**WARNING!**

1. *Be sure to turn the power off before cleaning the Cutter Module.*
2. *As the cutter blade is sharp, care should be taken not to injure yourself while cleaning.*

The disc cutter are available as an option.

1. Loosen the two Plastic Head Screws to remove the Cutter Cover.
2. Remove the jammed paper.
3. Clean the Cutter with a soft cloth slightly moistened with alcohol.
4. Attach the Cutter Cover.

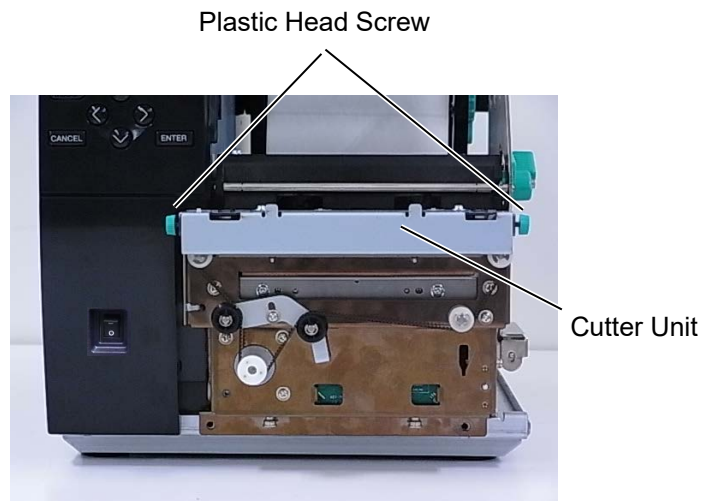

## 4. PRINTER SPECIFICATIONS

This section describes the printer specifications.

Item	Model	B-EX4T3-HS12-QM/CN-R
Dimension (W x D x H)		278 mm x 460 mm x 310 mm (10.9" x 18.1" x 12.2")
Weight (kg)		17 kg
Operating temperature range		5 degC to 40 degC (40 degF to 104 degF)
Relative humidity		25% to 85% RH (no condensation)
Power supply		Universal switching power source AC 100 V to 240 V, 50/60 Hz +/- 10%
Input voltage		AC100 V to 240 V, 50/60 Hz +/- 10%
Power	During a print job*	110W
Consumption	During stand-by	15W or less
	During sleep mode	4.7W
Resolution		600 dpi (23.6 dots/mm)
Printing method		Thermal transfer
Printing speed		50.8 mm/sec. (2 inches/sec.) 76.2 mm/sec. (3 inches/sec.) 101.6 mm/sec. (4 inches/sec.) 127.0 mm/sec. (5 inches/sec.) 152.4 mm/sec. (6 inches/sec.)
Available media width (including backing paper)		25.0 mm to 110 mm (0.98 inches to 4.33 inches)
Effective print width (max.)		104.0 mm (4.1 inches)
Issue mode		Batch Strip (Strip mode is enabled only when the optional Strip Module is installed.) Cut (Cut mode is enabled only when the optional Cutter Module is installed.)
LCD Message display		Graphic type 128 x 64 dots

\*: While 20% slant lines are printed in the specified format.

Item \ Model	B-EX4T3-HS12-QM/CN-R
Barcode types	JAN8, JAN13, EAN8, EAN8+2 digits, EAN8+5 digits, EAN13, EAN13+2 digits, EAN13+5 digits, UPC-E, UPC-E+2 digits, UPC-E+5 digits, UPC-A, UPC-A+2 digits, UPC-A+5 digits, MSI, ITF, NW-7, CODE39, CODE93, CODE128, EAN128, Industrial 2 to 5, Customer Bar Code, POSTNET, KIX CODE, RM4SCC (ROYAL MAIL 4 STATE CUSTOMER CODE), GS1 DataBar
Two-dimensional code	Data Matrix, PDF417, QR code, Maxi Code, Micro PDF417, CP Code, GS1 Data Matrix, AZTEC Code, GS1 QR Code
Font	Bitmap font (21 types), Japanese Kanji (JIS X0213/4 types Gothic, 2 types Mincho), Chinese, Outline font (8 types), Writable character, True Type Font
Rotations	0, 90, 180, 270 deg
Standard interface	USB interface Serial interface LAN interface
Optional interface	Parallel interface (B-EX700-CEN-QM-R) Expansion I/O interface (B-EX700-IO-QM-R) USB host interface (B-EX700-RTC-QM-R)

**NOTES:**

- *Data Matrix™ is a trademark of International Data Matrix Inc., U.S.*
- *PDF417™ is a trademark of Symbol Technologies Inc., US.*
- *QR Code is a trademark of DENSO CORPORATION.*
- *Maxi Code is a trademark of United Parcel Service of America, Inc., U.S.*

## 5. SUPPLY SPECIFICATIONS

### 5.1 Media

Please make sure that the media being used is approved by Toshiba Tec. The warranty does not apply when a problem is caused by using media that is not approved by Toshiba Tec.

For information regarding Toshiba Tec approved media, please contact a Toshiba Tec authorized service representative.

#### 5.1.1 Media Type

Two types of media can be loaded for this printer: label or tag. The table below shows size and shape of the media available for this printer.

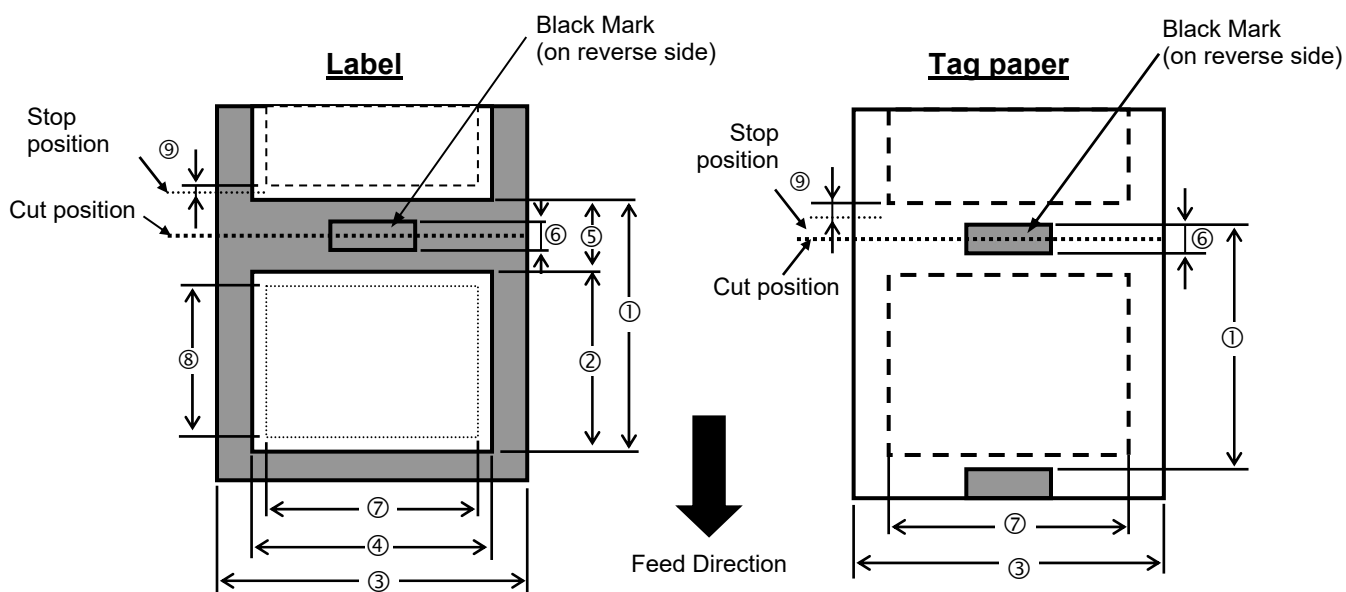

		B-EX4T3-HS		
		Batch	Cutter	Peel-off (*1)
① Pitch	Min.	5mm	25mm	5mm
	Max.	500mm	500mm	256mm
② Label Length	Min.	3mm		
	Max.	498mm	497mm	254mm
③ Backing paper Width	Min.	25mm		
	Max.	110mm		
④ Label Width	Min.	13mm		
	Max.	108mm		
⑤ Gap	Min.	2mm	3mm	2mm
	Max.	20mm		
⑥ Black mark length	Min.	2mm	3mm	2mm
	Max.	20mm		
⑦ Effective print Width	Max.	104mm		
⑧ Effective print Length	Min.	3mm		
	Max.	498mm	497mm	254mm
⑨ Print speed up/slow down area	Slow up	1mm		
	Slow down	1mm		
Thickness	Min.	0.13mm		
	Max.	0.17mm		
Max. outer roll diameter		Φ200mm(Φ180, When using built-in Rewinder) *Φ170, when paper tube inner diameterφ50.8		
Roll-up method		Inner •Outer		
Paper core		ID φ76.2±0.3mm		

(\*1) When using the High precision peel-off module (B-EX904-HH-QM-R) .

**NOTES:**

1. To ensure print quality and print head life use only Toshiba Tec specified media.
2. When the Disc cutter is used, the minimum label length shall be 18.0 mm – (Gap length/2) or longer.
3. The ratio of a label length to a gap length must be a minimum of 3 to 1 (3:1).
4. When using label stock in cut mode, be sure to cut in the gaps. Cutting labels will cause the adhesive to stick to the cutter, which may affect the cutter performance and shorten the cutter life.

### 5.1.2 Detection Area of the Transmissive Sensor

The Transmissive Sensor is movable from the center to the left edge of media.  
 The Transmissive Sensor detects a gap between labels, as illustrated below.

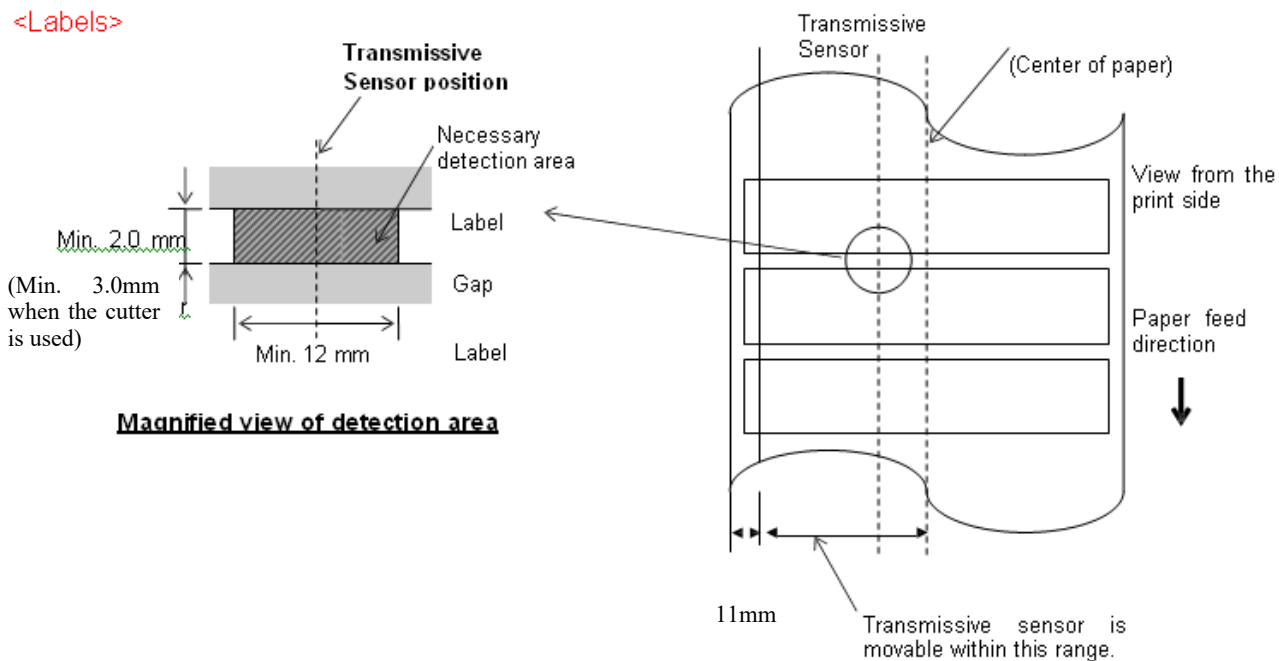

**NOTE:**  
 Round holes are not acceptable.

### 5.1.3 Detection Area of the Reflective Sensor

1. The sensor is movable in the range from the center of the paper to the left end.
2. The reflectance of the black mark must be 10% or less with a waveform length of 950 nm.
3. The sensor detects at the center of the black mark.
4. The black marks, if necessary, must be printed on the labels in the gap areas.
5. Rectangular holes can substitute the black marks, on the condition that nothing is printed on the back side. Round holes cannot be detected by the reflective sensor.

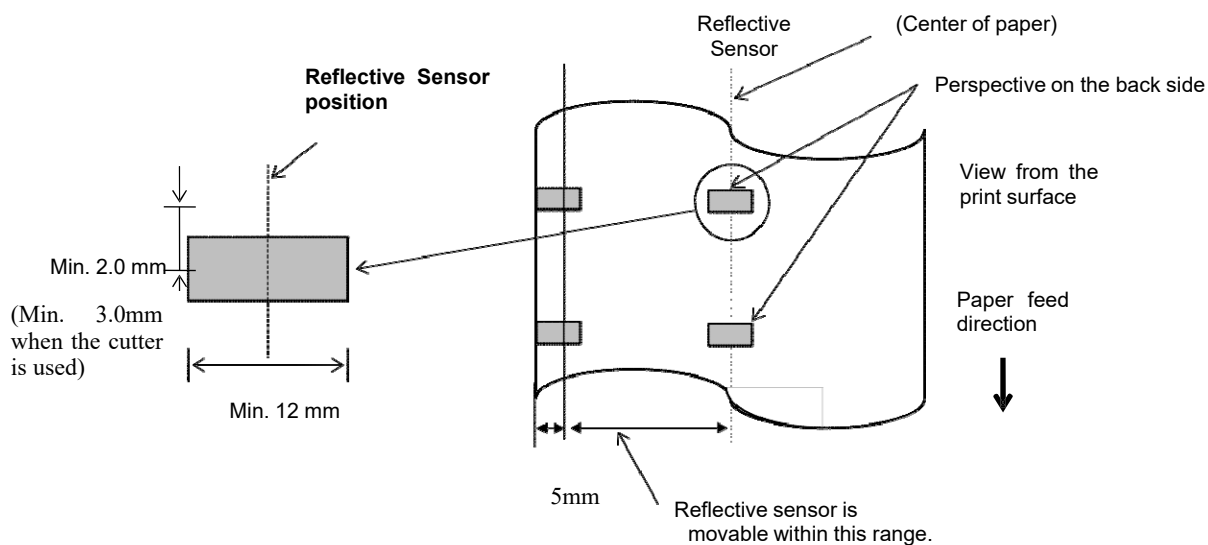



### 5.1.4 EFFECTIVE PRINT AREA OF PAPER

#### 5.1.4.1 Relationship between Print Head Effective Print Width and Paper Width

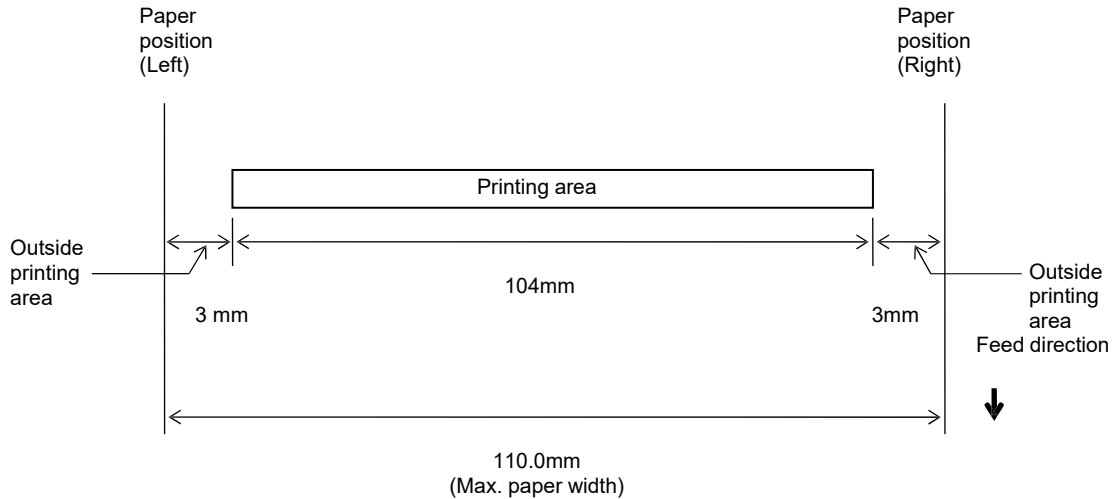

#### 5.1.4.2 Effective Print Area of Tags and Labels

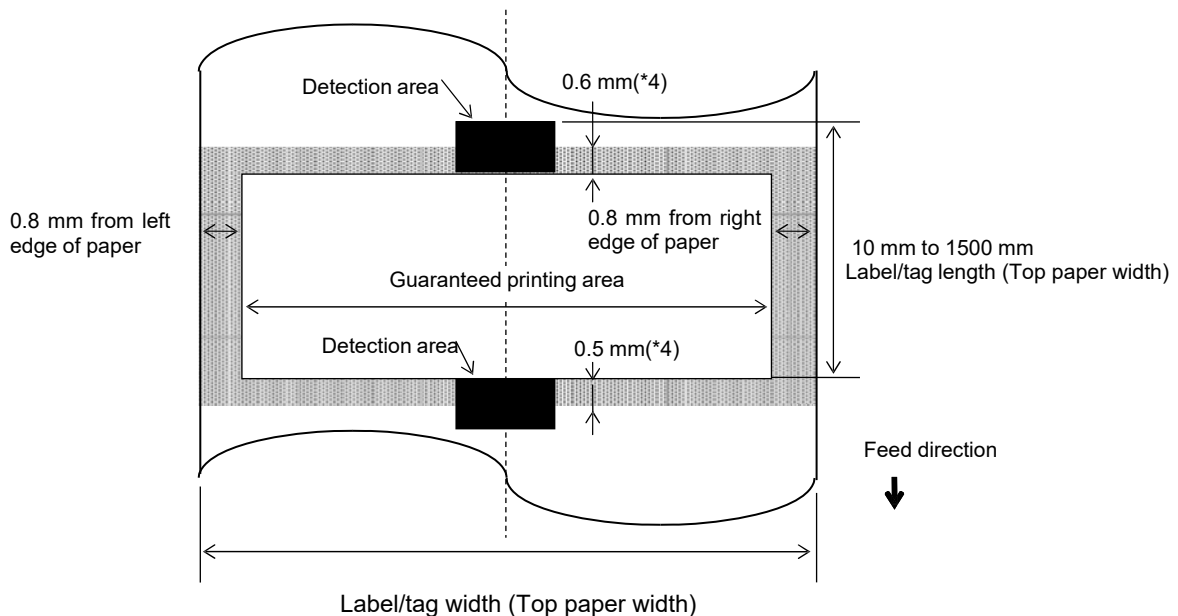

**NOTES:**

1. *Print quality in the shaded area is not guaranteed. For the label, printing in the 1-mm width area around the label is not guaranteed as well as the shaded area shown above.*
2. *The center of the paper (label and tag) is almost aligned with the center of the print head.*
3. *If printing is performed in the shaded area, the ribbon may wrinkle. This may affect the print quality of the guaranteed printing area.*
4. *0.8mm when print speed 2ips at continuous and peel-off, 1.2mm when print speed is 3ips~6ips. 1.0mm when print speed 2ips at cut, 1.6mm when print speed is 3ips~6ips.*

## 5.2 Ribbon

Please make sure that the ribbon being used is approved by Toshiba Tec. The warranty does not apply to any problem caused by using non-approved ribbons.

For information regarding Toshiba Tec approved ribbon, please contact a Toshiba Tec service representative.

	<b>B-EX4T3-HS</b>
Ribbon Width	40mm to 115mm
Max Ribbon Length	300m.
Max Ribbon OD	Φ70mm
Ribbon Core	Φ25.7 ±0.3mm
Type	Flat head
Ribbon winding	Outside

The table below shows the correlation between ribbon width and media width (backing paper is not included.)

Ribbon width	Media width
60 mm	25 - 55 mm
90 mm	56 – 85 mm
110 mm	86 – 105 mm
115 mm	106 – 110 mm

### NOTES:

1. To ensure print quality and print head life use only Toshiba Tec specified ribbons.
2. To avoid ribbon wrinkles use a ribbon that is wider than the media by 5 mm or more. However, too much difference in width between the two may cause wrinkles.

## 5.3 Recommended Media and Ribbon Types

Media type	Description
Vellum paper and labels	General use for low cost applications.
Coated paper	Matt coated paper General use including applications that require small letters and/or symbols. Glossy coated paper Used where a high-grade finish is required
Plastic films	Synthetic film (Polypropylene, etc.) This water-proof and solvent-resistant material has high physical strength and low-temperature resistance, but poor heat resistance (dependant upon material). This material can be used for labels stuck to recyclable containers, so it can be recycled in the same process. PET film This water-proof and solvent-resistant material has high physical strength, and low-temperature resistance as well as heat resistance. This material is used for many applications, especially where high durability is required. Mode/serial plate labels, caution labels, etc. Polyimide This material gives the best performance on heat resistance (greater than PET film). It is often used for PCB labels as it can withstand passage through a solder bath.

### 5.3 Media and Ribbon Types (Cont.)

Ribbon type	Description
Smear-less ribbon (Wax resin ribbon)	Good match for coated paper. The printed image will resist water and light rubbing.
Scratch and solvent resistance ribbon	Very good match for plastic films (synthetic paper, PET, polyimide, etc.) Scratch and solvent resistance Heat resistance with PET and polyimide.

#### Combination of Media and Ribbon

Media type \ Ribbon type	Vellum paper and label	Coated paper	Plastic films
Smear-less ribbon (wax-resin ribbon)		○	
Scratch/solvent resistance ribbon			○

○: Good match

### 5.4 Care/Handling of Media and Ribbon

#### CAUTION!

*Be sure to carefully review and understand the Supply Manual. Use only media and ribbons that meet specified requirements. Use of non-specified media and ribbons may shorten the head life and result in problems with barcode readability or print quality. All media and ribbons should be handled with care to avoid any damage to the media, ribbons or printer. Read the guidelines in this section carefully.*

- Do not store the media or ribbon for longer than the manufacturer's recommended shelf life.
- Store media rolls on the flat end. Do not store them on the curved sides as this might flatten that side causing erratic media advance and poor print quality.
- Store the media in plastic bags and always reseal after opening. Unprotected media can get dirty and the extra abrasion from the dust and dirt particles will shorten the print head life.
- Store the media and ribbon in a cool, dry place. Avoid areas where they would be exposed to direct sunlight, high temperature, high humidity, dust or gas.
- Some ink used on pre-printed media may contain ingredients which shorten the print head's product life. Do not use labels pre-printed with ink which contain hard substances such as carbonic calcium (CaCO<sub>3</sub>) and kaolin (Al<sub>2</sub>O<sub>3</sub>, 2SiO<sub>2</sub>, 2H<sub>2</sub>O).

For further information, please contact your local distributor or your media and ribbon manufacturers.



# Toshiba Tec Corporation

Copyright © 2015-2021 Toshiba Tec Corporation, All Rights Reserved  
1-11-1, Osaki, Shinagawa-ku, Tokyo 141-8562, Japan

**EN**

R210120X0000-TTEC

## Update Information

### Other information

- Please contact your authorized Toshiba Tec Corporation representative for the latest version of the manual.

### Troubleshooting

<b>Symptom</b>	<b>Cause</b>	<b>Solutions</b>
Printing is done intermittently.	This will occur in order to cool down a print head whose temperature has become heated during a long-time continuous printing sequence.	Continue to use the printer in this condition. There is no problem in the life and safety of the printer.